

MANUAL

MODEL: NC25A-12(24, 36, 48)

Ultra High Efficiency
25 Ampere Alternative Energy Battery
Charge Controller
 For GEL, AGM, and Flooded Cell Lead Acid Batteries

12V Controller Shown Below

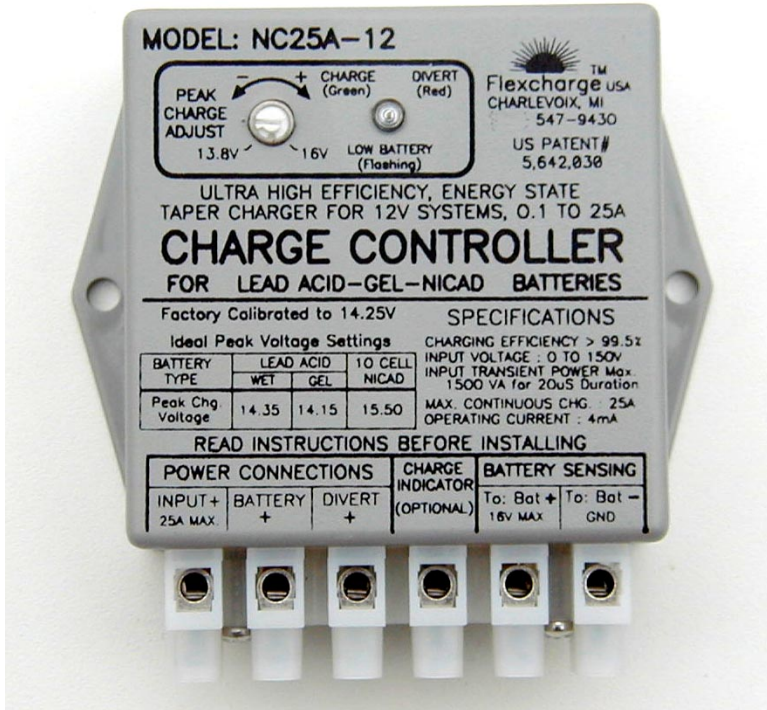

Patented

Rev 03, Ver1
 DEC 2012

SES Flexcharge USA, 1217 State St., Charlevoix, MI 49720
 Ph: 231-547-9430, Web Site: www.flexcharge.com

IMPORTANT INFORMATION

THE NC25 CONTROLLER IS AN "ON/OFF" REGULATOR NOT A CONSTANT VOLTAGE REGULATOR, AND THEREFORE IT CANNOT BE TESTED BY SIMPLY MEASURING THE OUTPUT VOLTAGE ON THE TERMINAL STRIP OF THE CONTROLLER. THE CONTROLLER MUST BE CONNECTED AS SHOWN IN ONE OF THE SCHEMATICS BEFORE IT WILL REGULATE.

READ ALL OF PAGES 5 through 8 OF THIS MANUAL TO LEARN HOW THE CONTROLLER REGULATES BEFORE CONCLUDING THAT YOUR CONTROLLER IS NOT REGULATING.

All wire to wire and crimp connections must be soldered for this, or any charge controller to operate dependably.

Do not solder on the controllers terminal block.
The terminals on the controller are coated with an anti corrosion coating.

Table Of Contents	
Page	Contents
1	Cover
2	Table Of Contents
3	Features
4	Controls and Indicators
5	Installation Instructions
7	Indicator Functional Description
8	<i>Flexcharge</i> Energy State Charge Method (ESCM)
9	Operating Characteristics - Wire Selection Chart - Diode Selection Chart
10	Using or Not Using Blocking Diodes
11	Solar Panels Charging One Battery Bank
12	Solar Panels Charging Two Battery Banks
13	Wind/Water Generator Charging One Battery Bank
14	Wind/Water Generator Charging Two Battery Banks
15	Solar with Wind/Water Generator Charging One Battery Bank
16	Solar with Wind/Water Generator Charging Two Battery Banks
17	Charging Two Battery Banks Using a Selector Switch
18	Charging Two Battery Banks Using an A/B Battery Switch (Not Recommended)
19	Charging From Smaller Outboard Motors
20	Expanding the NC25A to Regulate High Ampere Charging Sources
21	Troubleshooting Guide
22	Charging Efficiency Graphs
23	General Guidelines for Designing Your System, and Warranty Information

Features

- * **5 YEAR WARRANTY.**
- * **COMPLETELY SEALED ELECTRONICS FOR MARINE OR OUTDOOR MOUNTING.**
- * **LOW BATTERY VOLTAGE INDICATOR. (FLASHING RED LIGHT).**
- * **Works with GEL, AGM, and Flooded Cell Lead Acid Batteries. Also for flooded Ni-Cad Batteries**
- * **ARC REDUCTION CIRCUITRY TO ELIMINATE OR REDUCE RELAY CONTACT WEAR.**
- * **CHARGING EFFICIENCY BETTER THAN 99.50% FROM 0.5A TO 30A OF CHARGING CURRENT.**
- * **OPERATES EFFICIENTLY (98%) WITH AS LITTLE AS 0.1A OF SOLAR PANEL CHARGING CURRENT.**
- * **EFFICIENTLY CHARGES BATTERIES FROM 0 VOLTS WITH FULL POWER.**
- * **No RFI or EMI emissions to interfere with radio or data logging equipment**
- * **25 AMP CHARGE CAPACITY. SPECIAL ORDER 24V, 36V, AND 48V MODELS, OR EXPANDED MODELS WITH CHARGING CURRENT CAPACITIES UP TO 2000A.**
- * **25 AMP CHARGE DIVERT CIRCUIT. STABLE DIVERT CIRCUITRY PREVENTS ERATIC RELAY SWITCHING IF CHARGE SOURCE VOLTAGE DROPS.**
- * **DIVERTS ONLY WHEN VOLTAGE AND CURRENT ARE AT USABLE LEVELS. PERFECT FOR MOTOR TYPE DIVERT LOADS (FANS, PUMPS, etc...)**
- * **PEAK CHARGE VOLTAGE ADJUSTMENT WITH A RANGE OF 13.8V TO 15.9V (Multiply by 2,3,or 4 to determine voltages for 24V, 36V, or 48V versions).**
- * **CHARGES WITH THE SAME HIGH ACCURACY VOLTAGE SENSING THROUGH BATTERY ISOLATORS.**
- * **CONSUMES LESS THAN 5mA (0.005A) WHILE CHARGING AND AT NIGHT, 2mA IF YOU DO NOT USE THE CHARGE INDICATOR.**
- * **CHARGES BATTERIES AT FULL POWER, BELOW THE PLATE SATURATION POINT, THIS CHARGES BATTERIES FASTER, AND REDUCES ELECTROLYTE DEPLETION BY UP TO 90% OVER CONVENTIONAL CONSTANT VOLTAGE, PWM, & HIGH FREQUENCY CHARGE REGULATORS.**
- * **BATTERIES START CHARGING AT 0.005A OF CHARGE CURRENT.**
- * **CONTROLLER CAN WITHSTAND OPEN CIRCUIT INPUT SPIKES OF 1500VA, & 140V CONTINUOUS WITHOUT DAMAGE.**
- * **REVERSE POLARITY AND TRANSIENT VOLTAGE PROTECTION ON THE BATTERY SENSE WIRES.**
- * **NO POWER WASTING SAMPLE PERIODS.**
- * **REMOTE BATTERY VOLTAGE SENSING SO THE CONTROLLER CAN BE MOUNTED ANYWHERE BETWEEN THE CHARGING SOURCE AND THE BATTERIES.**
- * **EASY TO INSTALL USING THE LABELED CORROSION RESISTANT NICKEL / BRASS / STAINLESS STEEL CONNECTOR.**
- * **U/L 94V-O RATED ENCLOSURE AND UL LISTED OR RECOGNIZED COMPONENTS.**

Use Flooded Cell Battery settings for all AGM type batteries.

Peak Charge Voltage Adjustment

Factory Calibrated for use with Lead acid and Gel and AGM Battery Technologies. Look for the small calibration dent in the case

Do not move this adjustment unless you have special battery voltage requirements.

System Voltage

12= 12V, 24=24V, 36=36V, etc

Multi Function Indicator

See the table on page 7 for description of operation

Call Direct to the Manufacturer. Technical Questions, Warranty info, etc 231-547-9430

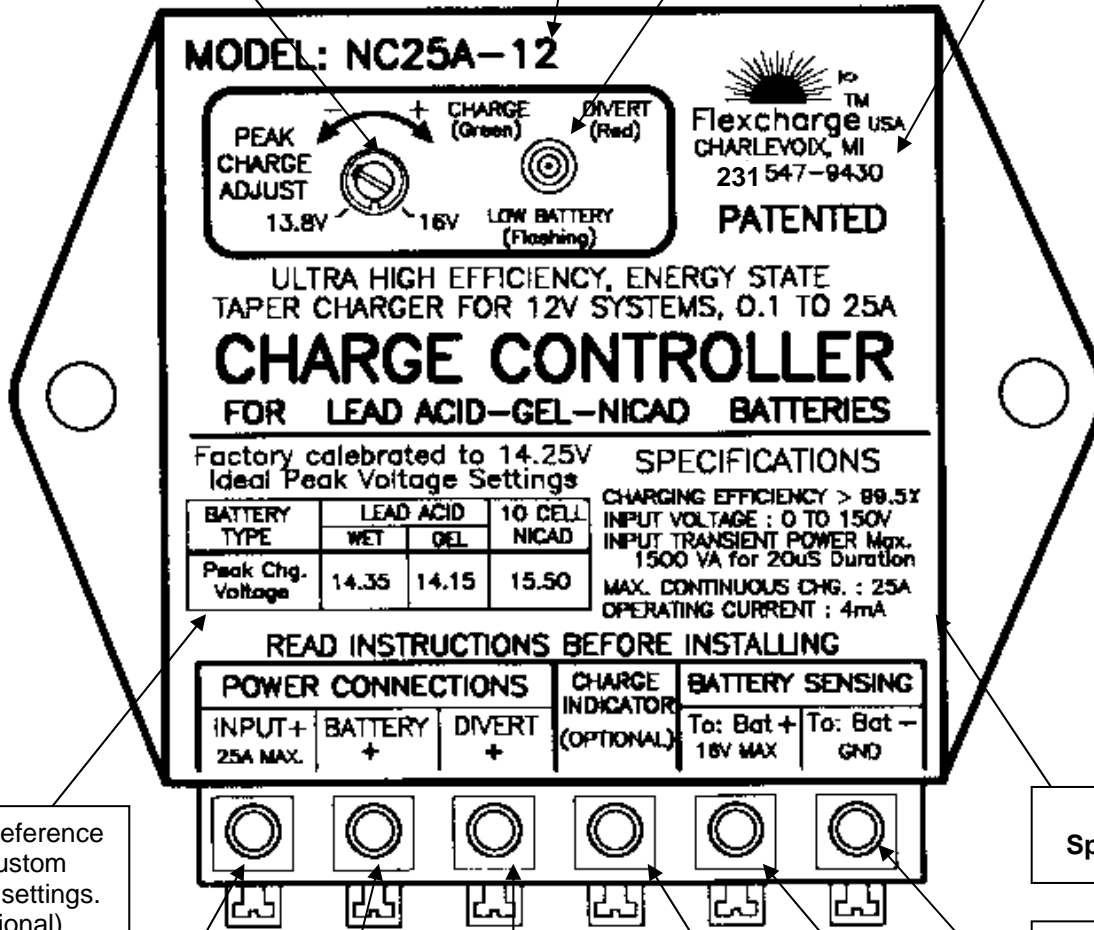

Quick Reference for custom voltage settings. (Optional)

General Specifications

CONNECT DIRECTLY TO THE BATTERY'S NEGATIVE (-) TERMINAL

Charging Input

Connect the Positive Wire from the Charging Source here.

Controller Output to Battery

Connect to Fuse then to Battery +

Divert Output

Connect to a Fuse then to Divert Load Positive (Optional)

See Installation Drawings.

Using the charge Indicator is optional

CONNECT DIRECTLY TO A FUSE THEN TO THE BATTERY'S POSITIVE (+) TERMINAL

INSTALLATION INSTRUCTIONS

*Flexcharge*TM USA NC25A

ULTRA HIGH EFFICIENCY CHARGE CONTROLLER

Congratulations, you will soon be using the most efficient controller available. Using this controller has the direct equivalency of increasing your solar panel capacity by up to 20% over any other controller *Flexcharge*TM USA has examined. This controller is available with capacities to 2000 amps with the same, or increased charging efficiencies.

NOTE: The NC25A does not contain any blocking diodes.

IMPORTANT: PLEASE READ THE SECTION "USING BLOCKING DIODES" Pg.10

- 1) **Choose a good mounting location.**
Even though the controller has been designed for mounting outside, mounting it in a more protected environment will help to extend it's operational life.
- 2) **Install the NEGATIVE BATTERY SENSE WIRE from the controller's terminal block to the battery bank negative (-) terminal. *You should use #16 to #14 awg black wire.***
- 3) **Install the POSITIVE BATTERY SENSE WIRE from the controller's terminal block to a 1A or 2A fuse and then to the battery bank's positive (+) terminal. *You should use #16 to #14 awg yellow or red wire.***

IMPROTANT

When installing the terminals on to the sense wires for connection to the battery, crimp then solder the terminals to the wire. Make absolutely sure these wires make very good electrical and mechanical connection with the battery's terminals. If either of this or the ground connections were to loosen, or corrode, the controller will have no way to sense battery voltage, causing it to switch to a non-regulating mode and overcharge the batteries. The sense wires may be extended up to 100 feet using #14 or larger wire. *All splice joints must be soldered.* If you are charging multiple isolated battery banks through a battery isolator, connect the SENSE wires to the primary (most used) battery bank. The other batteries will follow the primary battery's voltage, and will not be over or under charged.

IMPORTANT

For the next four steps, see the Wire Size Table on page 9 to select the correct size wire for your charging current and length of wire.

- 4) **Connect the charging source negative (-) wire to the negative (-) terminal on the battery and/or the system's negative battery bus.** If you are using a smart battery fuel meter that measures total Input to Output Amp/Hours, it will usually have a shunt in the (-) connection to the battery. Connect the (-) wire from the charging source to the shunt as shown in the meter's manual.
- 5) **Install the BATTERY POSITIVE (BAT. +) wire from the controller to the battery's positive terminal. A fuse rated at 1.5 times larger than your maximum charging current, but less than 30A, should be installed in this wire near the battery.** Remember to solder all wire connectors even if they use crimped connectors.

- 6) **Connect the charging source (Solar, Wind, etc.) positive wire to the controller's INPUT+ terminal. CAUTION: IF THE SOLAR PANELS ARE EXPOSED TO LIGHT, THEY WILL BE GENERATING POWER. WIND SYSTEMS SPINNING UNCONNECTED CAN HAVE VOLTAGES ABOVE 100V.** It is preferred to stop the generator from turning before connecting the wires from it. There will be a spark when you attach this wire if the charging source is generating power, this may be OK if it is not turning very fast but be sure you are not near any flammable fumes. Turn off the source if possible.
- 7) **DIVERT Feature.** When installing a Divert Load, the following steps must also be followed.
You must use a properly sized Divert Load on wind and towed generator systems
- a) **Connect the Divert Load's negative (-) wire to the negative (-) terminal on the battery or the system's negative battery bus.** If you are using a smart battery fuel meter that measures total Input to Output Amp/Hours, it will usually have a shunt in the (-) connection to the battery. *Connect the (-) wire from the Divert Load to the battery (-) **not** to the shunt as shown in the meter's manual.*
- b) **Install a fuse rated at 1.5 times larger than your maximum charging current, but less than 30A, in the Divert wire near the controller's terminal block in the Divert Load's positive wire.**

Choosing the right Divert Load

The Divert output from the controller is **unregulated**. This means that when the controller is in Divert mode, this terminal is directly connected to the charging source, just as if there were no controller installed. (i.e. The solar panels connected directly to the Divert Load) If the divert load draws less current than the maximum charging current of your system, the load could burn up. The best rule of thumb is; either use a Divert Load with a voltage rating twice that of your battery system, or one that has the same voltage rating as the batteries but has a current rating equal to the maximum your system can generate. See the Flexcharge Divert loads at www.flexcharge.com

- 8) **CHARGE INDICATOR LIGHT. It is not necessary to use the Charge Indicator Light.** If you wish to use it, connect the CHARGE INDICATOR TERMINAL on the controller's terminal block, to one of the charging source's diodes, at the source end. For example; on a solar panel it would connect to the solar panel end of the diode. See the wiring diagrams. In order to maintain the ultra high charging efficiencies in the NC25A, it may not be feasible to use the charge indicator while charging from outboard motors or on certain wind generators. If you have access to the blocking diode in the charging source or you are charging through a dual battery isolator, then you can use the charge indicator. A ***much*** more informative indication of charging is an amp meter installed into the Red BAT+ wire anywhere between the controller and the battery.

This concludes the installation section.

If the controller does not function as you think it should, first check the troubleshooting guide in this manual, then call your dealer, or Flexcharge USA at (231) 547-9430. Web Site www.flexcharge.com

For an explanation of the multi function indicator operation, see the Indicator Function Table on page 7.

Setting the Peak Charge Adjustment Voltage to a new value

WARNING: Mis-adjustment of the controller could seriously damage your batteries over time.

NOTE: The PEAK CHARGE ADJUST was set at the factory to 2.375V per cell (14.25 volts for 12V systems). **All battery voltages are for batteries at 68 degrees F. Peak voltages should be set higher for colder temperatures and lower for warmer temperatures.** The Ideal voltage setting for Wet Cell Lead Acid and AGM Batteries is 2.39V per cell, (14.35V for 12V systems). The Ideal setting for Sealed Gel batteries is 2.35V per cell (14.15V for 12V systems). The 2.375V per cell position was marked with a small indent in-line with the slot in the adjuster. The 2.37V per cell voltage setting works well with Wet Cell Lead Acid, AGM and Gel battery Technologies. If you move the adjustment and want to put it back near the original setting, line up the slot as closely as possible with the small indent (dot) in the case. **You should recalibrate the controller if the adjustment is moved.**

- 1) **Setting a new regulated voltage, or checking the regulation voltage of your controller.**

NOTE: THE BATTERY BANK MUST BE FULLY CHARGED TO PERFORM THIS TEST, AND THE DIVERT LIGHT MUST BE OFF LONGER THAN 10 SECONDS AT A TIME. IF THE DIVERT LIGHT IS NOT OFF LESS THAN 10 SECONDS, COVER SOME OF THE SOLAR PANEL(S) WITH A BLANKET OR CARDBOARD TO SLOW THE CHARGE RATE. All Flexcharge controllers are 100% tested and calibrated at the factory.

- a) Connect an accurate digital voltmeter on the terminals of the battery you are charging.
- b) If you are only checking the unit, skip this step, and step "d". Turn the adjustment most of the way towards "+". The dot in the case near the adjustment is the factory setting of 2.375V per cell. Continued...
- c) Watch the voltmeter for the highest voltage you wish the batteries to charge to.
- d) SLOWLY turn the adjustment towards "-" until the DIVERT indicator comes ON (steady red or orange).
- e) Allow the controller to cycle a few times while watching the voltmeter, and fine tuning the adjustment for the exact upper switch voltage you desire. *Remember the controller will switch ON and OFF (Charge to Divert then back to Charge) while you are performing this test, and if it is switching too fast your voltmeter readings will be inaccurate which could cause you to set the controller at the wrong voltage.*

Easier Calibration Method

Note: The peak voltage setting on the NC25A is set to 2.375V per cell (14.25V for 12V systems only) at the factory. This voltage setting is ideal for sealed gel batteries that recommend a 14.10V constant voltage setting (see the charge process graph). The factory setting will also work with vented lead acid and AGM batteries, however setting the peak voltage at 14.35V will give the batteries a more active charge. You may use the method described in step 6, or an easier way may be to start your engine, and allow the engine alternator to charge your batteries up to about 14.4 volts. Then simply turn the adjustment on the NC25A towards "+" until the DIVERT light turns OFF then slowly turn it back until the DIVERT light comes ON. The NC25 will now regulate the battery voltage at the same voltage as your engine alternator, which is usually about 14.4V

Coat the battery's terminals with battery terminal grease to prevent future problems caused by corrosion.

NC25A controllers are available for 12, 24, 36, 48 volt systems with charging capacities of, 60 & 100 amperes. Special order units with 60 ampere up to 2000 ampere charging capacities.

For more information call your dealer or *Flexcharge*TM USA at 231-547-9430

Visit our Web Site: www.flexcharge.com

Description of Multi Function Indicator Operation

Indicator Function Description	Charge Indicator <i>Not Used</i>	Charge Indicator <i>Used</i>
Charging (Battery Voltage Is Above 11V)	none	STEADY Green
Charging (Battery Voltage Is Below 11V)	FLASHING Red	FLASHING- Green to Orange
Not Charging (Battery Voltage Is Below 11V)	FLASHING Red	FLASHING Red
Charge Divert	STEADY Red	STEADY Orange
Not Charging (Charging Source is NOT Making Power & Battery is Above 11V)	none	none

The *Flexcharge*TM Energy State Taper Charge Method

The Energy State Taper Charge Process monitors the battery for the full charged resting voltage of the cells. There are tremendous advantages to this charge method.

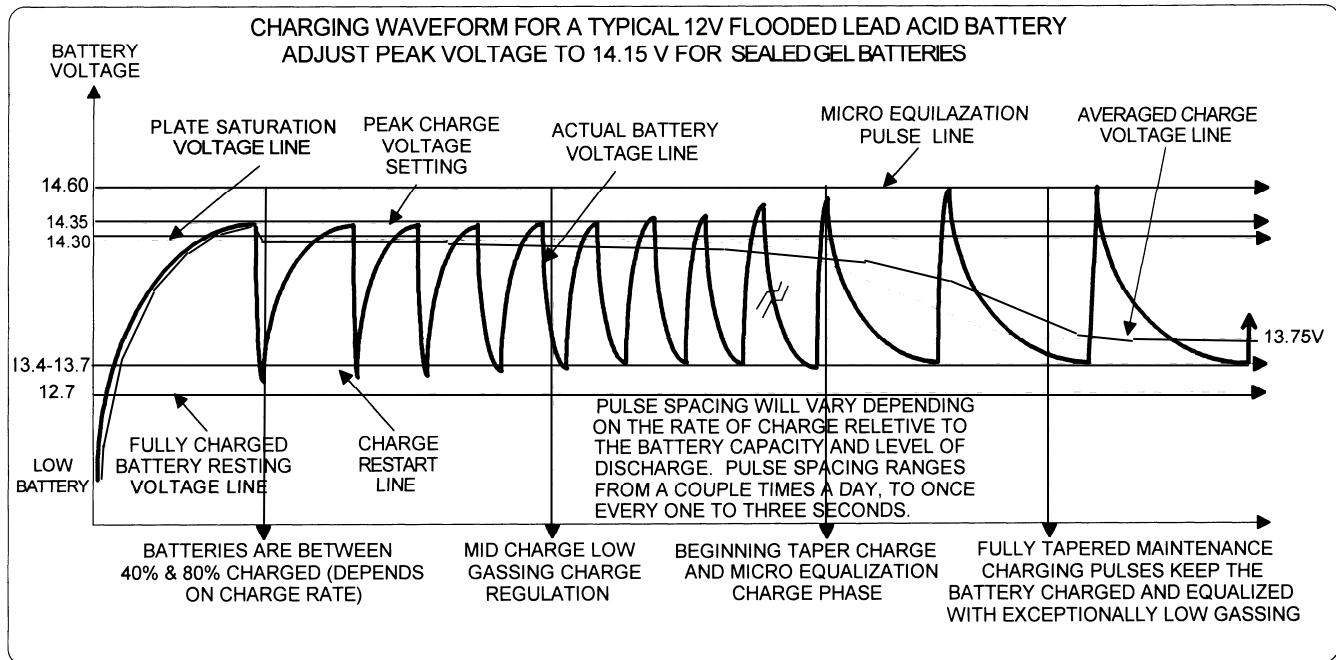

- * Zero overcharging
- * Exceptionally low gassing (Up to 90% less)
- * Non-Destructive Micro-Equalization at each full charge
- * The battery's chemical processes actually control the charging.
- * No RFI or EMI emissions to interfere with radio equipment.

The need for temperature compensation is greatly reduced because the plate voltage is not constantly held at the critical plate saturation point. Tapering is controlled by the battery's level of charge rather than a set timer and fixed voltage as in PWM and other constant voltage charge methods. The battery takes exactly what it needs rather than being forced to take a set voltage. With the **Flexcharge** method you can charge your battery bank indefinitely without any possibility of overcharging. The batteries will last longer, require less watering maintenance, and hold a better charge.

As charging begins the controller allows full charging current to pass directly to the battery. When the battery voltage rises slightly above the plate saturation point, the controller opens the charging circuit. The chemical charging process continues until the battery voltage floats down to a voltage slightly above 13.6V. At this point the battery is ready to accept another charge pulse. This charge regulation method is actually controlled by the battery's ability to accept energy. When the battery needs more energy, the controller applies it. Later in the charging cycle the controller will cycle ON and OFF sending full charge current pulses into the plates. A process which charges with very low gassing, and micro equalizes the cells at the same time. As the battery reaches a higher level of charge the amount of time the controller spends in charge is reduced, and the time in rest is increased. At full charge the controller will apply short duration pulses to maintain the battery at an average voltage of about 13.75 volts. This keeps gassing to a minimum while effectively trickle charging, and equalizing your battery bank.

Operating Characteristics

Flexcharge NC25A-12 (24,36,48)	Min.	Max.
Charge Input Voltage	0Vdc	140Vdc
Allowable Battery Voltage on Sense Wires 12V Systems <i>(Multiply by 2, 3, or 4 for 24V, 36V, or 48V Systems)</i>	0Vdc	16Vdc
Standby/Operating Current of the Controller	2mA	7mA
Charging Amperes	0.005A	25A
Short Term Over-Current (1/2 Second Maximum)	-	50A
Total Charging Efficiency	98.9%	99.8%
Insertion Loss Resistance (Ohms)	0.001Ω	0.004Ω
Charge Divert Current	0A	25A
Charge Divert Over Current (1/2 Second)	-	50A
Transient Surge Protection (20uS)		1500VA
Operating Temperature	-40°C	+60°C
Storage Temperature	-55°C	+60°C
Case Dimensions	4"W x 3.75"H x 1.5" D	

HOOKUP WIRE SIZE CHART

This chart provides the minimum wire size to minimize power loss. Larger wires would be always better for operating efficiency

Max Charging Capacity	WIRE SIZE FOR 1 TO 10FT LENGTHS	WIRE SIZE FOR 10 TO 20FT LENGTHS
0A TO 3A	#14 AWG	#12 AWG
3A TO 6A	#12 AWG	#12 AWG
6A TO 12A	#10 AWG	#10 AWG
12A TO 18A	#10 AWG	#8 AWG
18A TO 25A	#8 AWG	#8 AWG

Diode Selection Table

Ampere Rating	Voltage Rating	Part Number	Type	Manufacturer
1A	40V	1N5819	Schottky	Diodes Incorporated
3A	40V	1N5822	Schottky	International Rectifier
5A	100V	50SQ100	Schottky	International Rectifier
8A	45V	80SQ045	Schottky	International Rectifier
1A	400V	1N4004	Silicon	Diodes Incorporated
3A	400V	1N5404	Silicon	Diodes Incorporated
6A	1000V	6A10	Silicon	Diodes Incorporated

If you cannot find these parts locally, call Flexcharge USA. Many of the above diodes are in stock.

READ THIS!! IMPORTANT: USING or NOT USING BLOCKING DIODES ON YOUR PV CHARGING SYSTEM?

There has been a great deal of discussion in the solar electric industry over the use of blocking diodes.

In an effort to clarify the topic *Flexcharge*TM USA has called, met with, or gathered information pertaining to the use of diodes from several solar panel and equipment manufacturers to verify the following information.

The following is a condensed version of the information to assist you in designing a failure resistant system.

What is a blocking diode?

A blocking diode is a one-way valve for electricity. The band on the case of the diode is the output, which should be installed towards the battery in the positive wire from each solar panel. There are two primary types of diodes, *Schottky* (sensitive to damage but low loss type) and *Silicon* (tough, but higher loss type). They are rated by the amount of current that can pass through them in amps, and the amount of voltage they can withstand in reverse. .

What is the function of blocking diodes in a solar system?

- 1 The diode will prevent the flow of electricity into the panels when the panels are not making electricity, and will prevent voltage spikes in the system from reaching the panels. They also prevent interaction between each solar panel in the system. Without diodes, a shaded panel will substantially reduce the output of the entire system.
- 2 A diode will prevent a damaged panel which has shorted (a common type of failure) from draining the battery system, or drawing power from the remaining good panels.

There are primarily three types of solar electric panel technologies being used today.

- 1) SINGLE CRYSTALLINE
- 2) POLY CRYSTALLINE
- 3) AMORPHOUS

How should blocking diodes be used with each type of panel?

SINGLE CRYSTALLINE panels are glass covered rigidly mounted panels. They have a low nighttime back flow of power from the batteries. The loss at night is actually a little less than the amount of loss you get by adding a blocking diode to the panel. On a single panel system you may get more out of your panel if you do not use a blocking diode on these type of panels, **On multiple panel arrays, blocking diodes should be used, especially** on unattended remote systems, to guard against a failed panel. Because they are glass covered, a stray falling branch, hailstones, a child with a rock, or bored hunter could bring the entire system down by damaging only one panel.

POLY CRYSTALLINE panels are also glass covered rigidly mounted panels. They have a slightly higher nighttime draw of power from the batteries when compared to single crystalline panels. The loss at night is near equal to the loss you get by adding a blocking diode to the panel. You may or may not get more out of your panel by using blocking diodes on these type of panels, **On multiple panel arrays, blocking diodes should be used, especially** on unattended remote systems, to guard against a failed panel. Because they are glass covered, a stray falling branch, hailstones, a child with a rock, or bored hunter could bring the entire system down by damaging only one panel.

AMORPHOUS panels are a very different when compared to the other types of panels. They have a fairly substantial nighttime draw of power from the batteries when compared to single crystalline panels. The loss at night is higher than the loss you get by adding a blocking diode to the panel; **in addition, these type panels could actually draw enough power from the batteries at night to damage themselves if diodes are not used.** To compensate for the diode loss, most amorphous panels have a higher operating voltage, to make up for the voltage drop losses of the diode.

Blocking diodes should be used on all systems when panels have been connected in series to charge 24V, or higher voltage batteries, or when using an inverter on the system. Inverters can cause voltage spikes as high as 60 volts on the DC positive wires. This is enough voltage to damage most solar panels.

In conclusion; blocking diodes should be used on all systems except, one panel single crystalline 12V systems. If your system is so marginal that using, or not using diodes will make the difference, consider adding another solar panel to your system.

See the previous page for a list of suggested blocking diodes for your system

SOLAR PANELS CHARGING ONE BATTERY BANK

DWG_1_PCB Setite: 751

Drawing Shows 12V System
If Your Controller is For Other
Voltage Systems, Multiply
all Voltages as Listed Below

Sys. Voltage Multiplier

- 24V (x2)
- 36V (x3)
- 48V (x4)

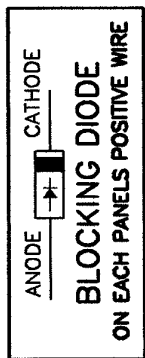
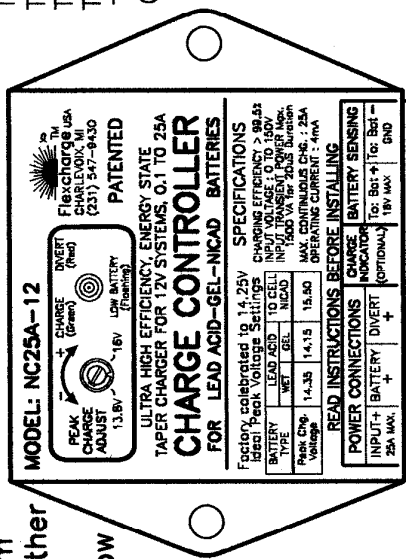

CAUTION STATEMENTS:

THE CONTROLLER WILL BE DAMAGED IF, WHILE CHARGING, THE POSITIVE SENSE WIRE, AND THE WIRE FROM THE BAT + TERMINAL ON THE CONTROLLER ARE CONNECTED TOGETHER, BUT REMOVED FROM THE BATTERY TERMINAL. TO PREVENT DAMAGE TO THE CONTROLLER, REMOVE ONE OF THE FUSES WHEN PERFORMING BATTERY MAINTNANCE

Do NOT charge a second battery bank with the Divert Output. It could be damaged by over or under charging

VOLTAGE SENSING WIRES MUST CONNECT DIRECTLY TO THE BATTERY'S TERMINALS. NUMBER #14 OR LARGER WIRE MUST BE USED FOR THE BATTERY SENSING WIRES

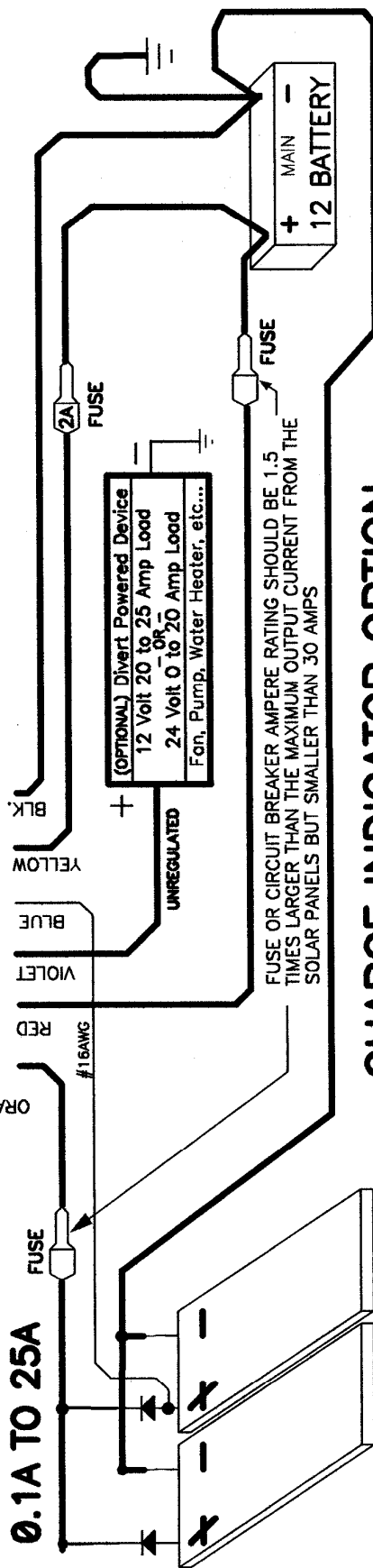

CHARGE INDICATOR OPTION

PANEL ISOLATION DIODES ARE USUALLY INSTALLED BY THE SOLAR PANEL MANUFACTURER TO PREVENT FLOW OF ELECTRICITY FROM ILLUMINATED PANELS INTO SHADED PANELS. SIMPLY CONNECT THE CHARGE INDICATOR WIRE TO THE ANODE SIDE OF THE BLOCKING DIODE ON ANY ONE OF THE PANELS. IF YOUR PANELS DO NOT HAVE ISOLATION DIODES, INSTALL THEM. THE DIODES SHOULD HAVE A AMPERE RATING OF 1.5 TIMES THE MAXIMUM CURRENT OF EACH PANEL, AND SHOULD BE RATED AT 40 VOLTS (OR HIGHER), UNLESS YOU WILL BE USING A WIND OR WATER POWERED GENERATOR, THEN USE A DIODE WITH A 200V OR HIGHER RATING.

SOLAR PANELS CHARGING TWO OR MORE BATTERY BANKS

DWG_2_PCB Scale: 75%

Drawing Shows 12V System
If Your Controller is For Other
Voltage Systems, Multiply
all Voltages as Listed Below

Sys. Voltage	Multiplier
24V	(x2)
36V	(x3)
48V	(x4)

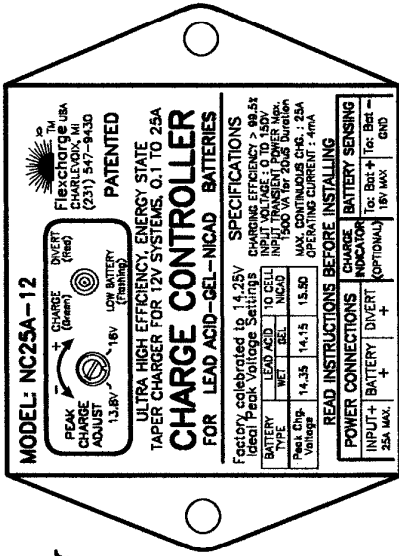

CAUTION STATEMENTS:

THE CONTROLLER WILL BE DAMAGED IF, WHILE CHARGING, THE POSITIVE SENSE WIRE, AND THE WIRE FROM THE BAT + TERMINAL ON THE CONTROLLER ARE CONNECTED TOGETHER, BUT REMOVED FROM THE BATTERY TERMINAL. TO PREVENT DAMAGE TO THE CONTROLLER, REMOVE ONE OF THE FUSES WHEN PERFORMING BATTERY MAINTENANCE

Do NOT charge a second battery bank with the Divert Output. It could be damaged by over or under charging

VOLTAGE SENSING WIRES MUST CONNECT DIRECTLY TO THE BATTERIES TERMINALS. ANY EXTENSIONS TO THIS WIRE MUST BE MADE WITH #14AWG WIRE OR LARGER.

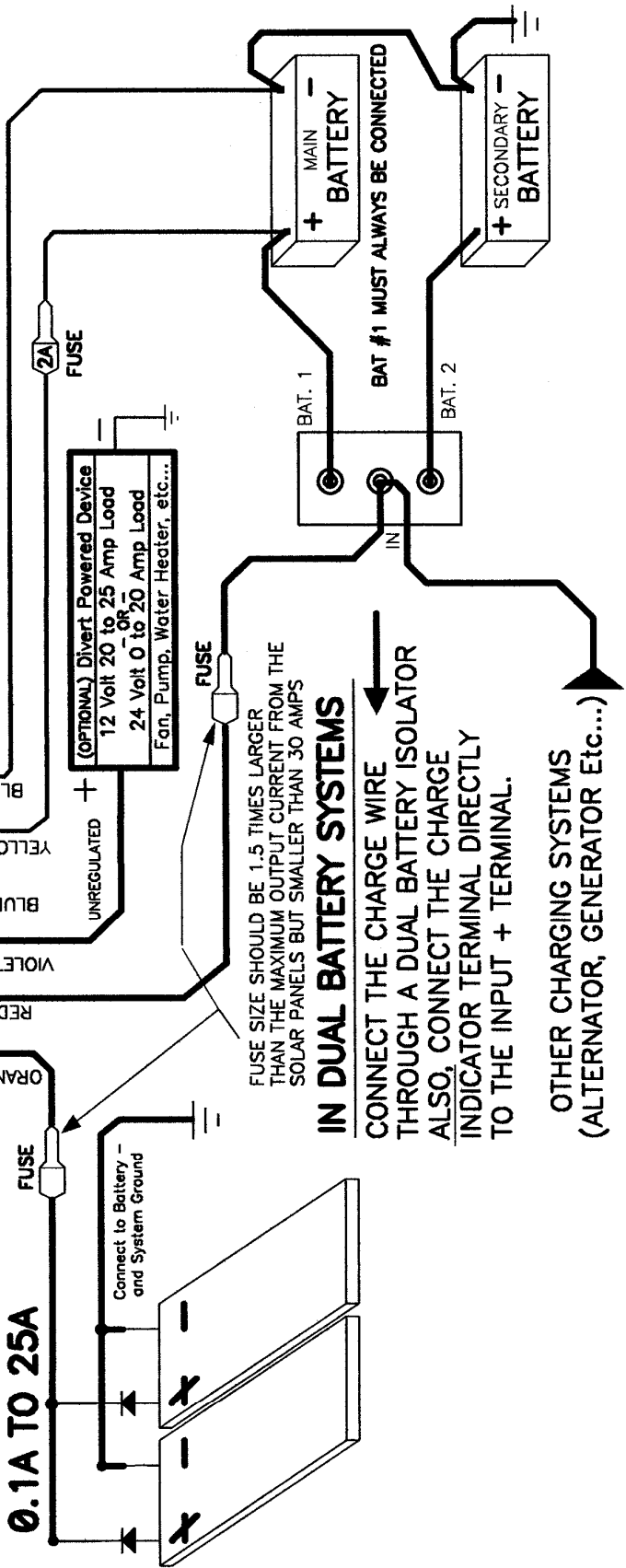

WIND CHARGING SYSTEM WITH ONE BATTERY BANK

DWG_3.PCB Scale: 75%

CAUTION STATEMENTS:

THE CONTROLLER WILL BE DAMAGED IF, WHILE CHARGING, THE POSITIVE SENSE WIRE, AND THE WIRE FROM THE BAT + TERMINAL ON THE CONTROLLER ARE CONNECTED TOGETHER, BUT REMOVED FROM THE BATTERY TERMINAL. TO PREVENT DAMAGE TO THE CONTROLLER, REMOVE ONE OF THE FUSES WHEN PERFORMING BATTERY MAINTNANCE

Do NOT charge a second battery bank with the Divert Output. It could be damaged by over or under charging

VOLTAGE SENSING WIRES MUST CONNECT DIRECTLY TO THE BATTERIES TERMINALS. ANY EXTENSIONS TO THIS WIRE MUST BE MADE WITH #14AWG WIRE OR LARGER.

IF YOUR WIND GENERATOR REQUIRES A LOAD RESISTOR TO PREVENT OVERSPEED CONDITIONS, CONNECT IT TO THE DIVERT TERMINAL.

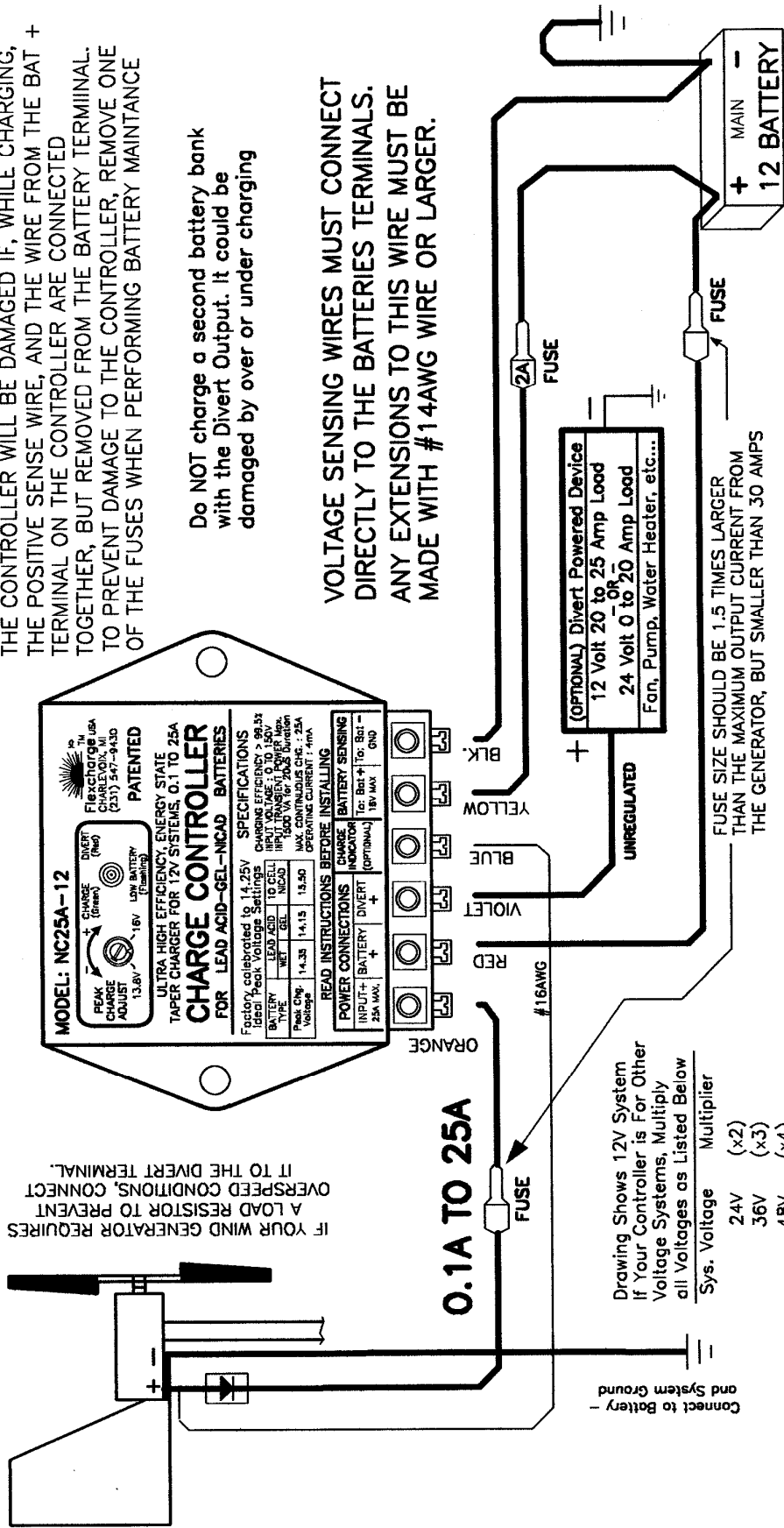

CHARGE INDICATOR OPTION

AN ISOLATION DIODE SHOULD BE INSTALLED IN THE GENERATORS POSITIVE WIRE TO PREVENT FLOW OF ELECTRICITY FROM THE BATTERY BACK INTO THE GENERATOR. SIMPLY CONNECT THE CHARGE INDICATOR WIRE TO THE ANODE SIDE OF THE BLOCKING DIODE (WIND GENERATOR SIDE). SOME GENERATORS INSTALL THE DIODES IN THE HOUSING. YOU WILL NOT BE ABLE TO USE THE CHARGE INDICATOR WITH THESE TYPES OF GENERATORS.

WIND CHARGING SYSTEM WITH TWO OR MORE BATTERY BANKS

DWG_4_PCB Scale: 75%

IF YOUR WIND GENERATOR REQUIRES A LOAD RESISTOR TO PREVENT OVERSPEED CONDITIONS, CONNECT IT TO THE DIVERT TERMINAL.

CAUTION STATEMENTS:

THE CONTROLLER WILL BE DAMAGED IF, WHILE CHARGING, THE POSITIVE SENSE WIRE AND THE WIRE FROM THE BAT + TERMINAL ON THE CONTROLLER ARE CONNECTED TOGETHER, BUT REMOVED FROM THE BATTERY TERMINAL. TO PREVENT DAMAGE TO THE CONTROLLER, REMOVE ONE OF THE FUSES WHEN PERFORMING BATTERY MAINTENANCE

Do NOT charge a second battery bank with the Divert Output. It could be damaged by over or under charging

VOLTAGE SENSING WIRES MUST CONNECT DIRECTLY TO THE BATTERY'S TERMINALS. ANY EXTENSIONS TO THIS WIRE MUST BE MADE WITH #14AWG WIRE OR LARGER.

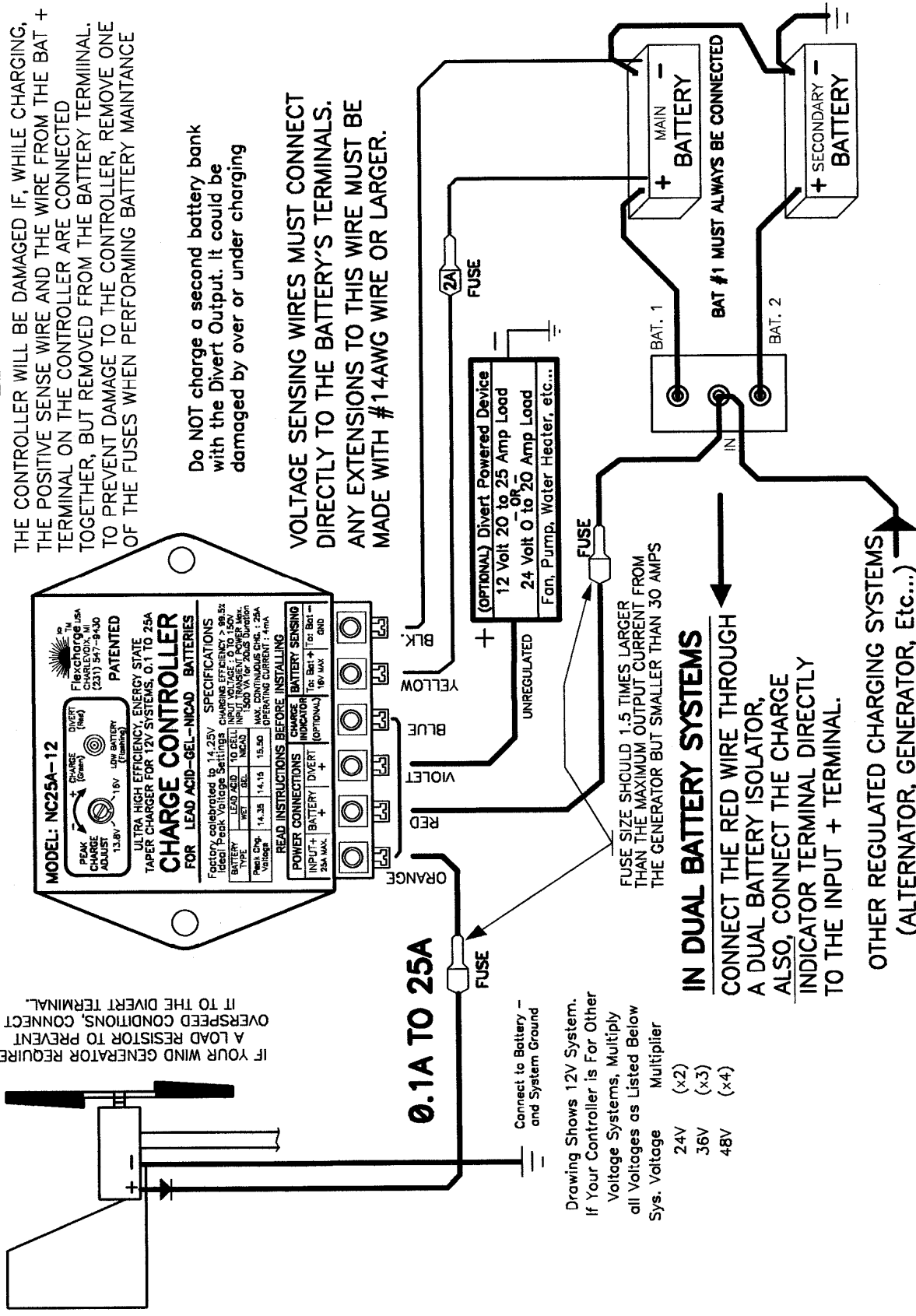
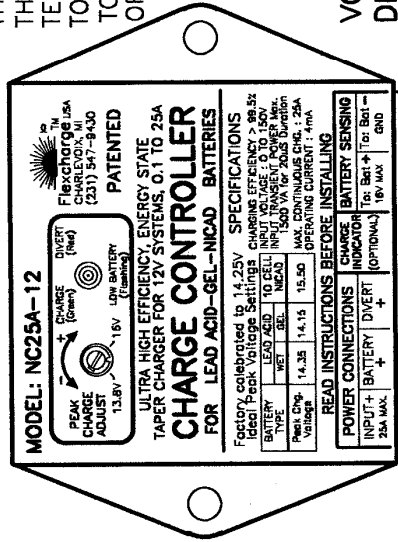

IN DUAL BATTERY SYSTEMS

CONNECT THE RED WIRE THROUGH A DUAL BATTERY ISOLATOR, ALSO, CONNECT THE CHARGE INDICATOR TERMINAL DIRECTLY TO THE INPUT + TERMINAL.

OTHER REGULATED CHARGING SYSTEMS (ALTERNATOR, GENERATOR, Etc...)

Drawing Shows 12V System. If Your Controller is For Other Voltage Systems, Multiply all Voltages as Listed Below

Sys. Voltage	Multiplier
24V	(x2)
36V	(x3)
48V	(x4)

CHARGING FROM WIND AND SOLAR AT THE SAME TIME INTO ONE BATTERY BANK

DWG_5_PCB Scale: 75%

CONNECT TO CHARGE INDICATOR
SEE NOTE A

WIND AND WATER GENERATORS
REQUIRE AN ELECTRICAL LOAD TO PREVENT
OVERSPEED CONDITIONS. CONNECT
IT TO THE DIVERT TERMINAL.

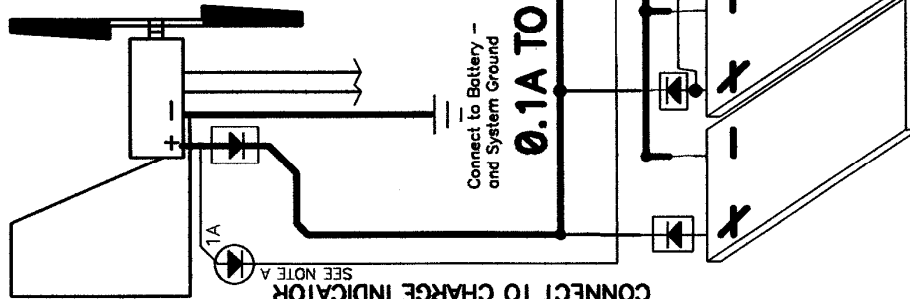

MODEL: NC25A-12

Flexcharge Inc.
CHARGE VOLT. ADJ.
(25) 347-4400

PEAK CHARGE ADJUST 13.8V

CHARGE (Green)

DIVERT (Red)

LOW BATTERY (Orange)

1.8V LOW BATTERY (Orange)

CHARGE CONTROLLER FOR LEAD-ACID-GEL-NICAD BATTERIES

ULTRA HIGH EFFICIENCY, ENERGY STATE TAPER CHARGER FOR 12V SYSTEMS, 0.1 TO 25A

Factory calibrated to 14.25V

Factory Voltage Settings		SPECIFICATIONS	
BATTERY TYPE	WEET	WEET	WEET
LEAD ACID	14.35	14.15	15.50
NICAD	14.35	14.15	15.50
GEL	14.35	14.15	15.50
INPUT VOLTAGE: 120 to 240 Vac			
INPUT TRANSFORMER POWER MAX.			
MAX. CONTINUOUS CHG. 25A			
OPERATING CURRENT: 1.5A			

READ INSTRUCTIONS BEFORE INSTALLING

POWER CONNECTIONS: CHARGE INDICATOR (OPTIONAL) TO: Bat+ TO: Bat- 25A MAX.

INPUT: BATTERY DIVERT +

CAUTION STATEMENTS:

THE CONTROLLER WILL BE DAMAGED IF, WHILE CHARGING, THE POSITIVE SENSE WIRE, AND THE WIRE FROM THE BAT + TERMINAL ON THE CONTROLLER ARE CONNECTED TOGETHER, BUT REMOVED FROM THE BATTERY TERMINAL. TO PREVENT DAMAGE TO THE CONTROLLER, REMOVE ONE OF THE FUSES WHEN PERFORMING BATTERY MAINTANCE

Do NOT charge a second battery bank with the Divert Output. It could be damaged by over or under charging

NOTE A

Drawing Shows 12V System. If Your Controller is For Other Voltage Systems, Multiply all Voltages as Listed Below

Sys. Voltage	Multiplier
24V	(x2)
36V	(x3)
48V	(x4)

USE THESE 1 AMP DIODES ONLY IF BOTH PV AND WIND ARE USED TOGETHER THE OTHER DIODES ARE BLOCKING DIODES (SEE "USING BLOCKING DIODES")

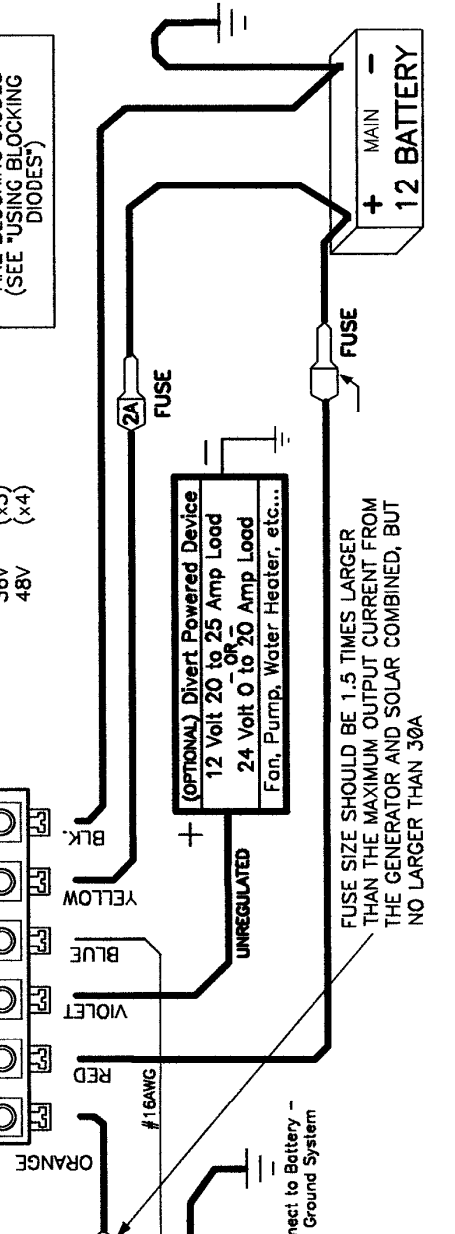

FUSE SIZE SHOULD BE 1.5 TIMES LARGER THAN THE MAXIMUM OUTPUT CURRENT FROM THE GENERATOR AND SOLAR COMBINED, BUT NO LARGER THAN 30A

READ - VERY IMPORTANT !!!!

The blocking diodes on the solar panels MUST HAVE A VOLTAGE A 200V OR HIGHER RATING to protect the panels from high voltage spikes that are normally produced by magnet generators. THE PANELS WILL BE DAMAGED IF YOU CHOOSE NOT TO USE THESE DIODES.

CHARGING FROM WIND AND SOLAR AT THE SAME TIME, INTO MULTIPLE BATTERY BANKS

DWG. S-PCB Scale: 70%

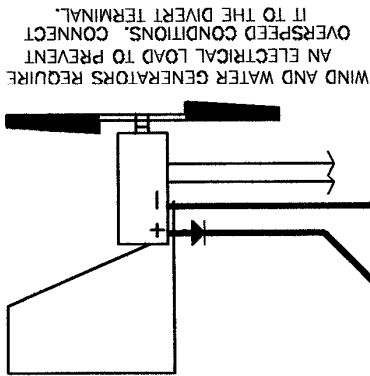

WIND AND WATER GENERATORS REQUIRE AN ELECTRICAL LOAD TO PREVENT OVERSPEED CONDITIONS. CONNECT IT TO THE DIVERT TERMINAL.

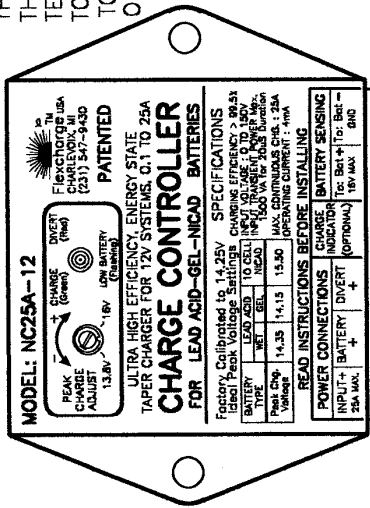

MODEL: NC25A-12
 Flexcharge™ PATENTED
 CHARGE ADJUST 1.3V - 1.8V
 DIVERT (12V) LOW BATTERY (12V)
 CHARGE (12V)
CHARGE CONTROLLER
 FOR LEAD-ACID-GEL-NICAD BATTERIES
 ULTRA-HIGH EFFICIENCY ENERGY STATE
 TAPER CHARGER FOR 12V SYSTEMS. 0.1 TO 25A
 Factory Calibrated to 14.25V
 Charge Voltage Range: 13.8V to 14.8V
 Charge Current Range: 0.1A to 25A
 Max. Continuous Charge Current: 25A
 Max. Operating Temperature: 120°F
 Max. Ambient Temperature: 100°F
 Max. Humidity: 95%
 Max. Operating Current: 40A
 Max. Output Current: 25A
 Max. Output Voltage: 14.8V
 Max. Output Power: 375W
 Max. Output Energy: 100Wh
 Max. Output Efficiency: 95%
 Max. Output Voltage Regulation: ±0.5%
 Max. Output Current Regulation: ±1.0%
 Max. Output Power Regulation: ±1.0%
 Max. Output Energy Regulation: ±1.0%
 Max. Output Efficiency Regulation: ±1.0%
 Max. Output Voltage Regulation: ±0.5%
 Max. Output Current Regulation: ±1.0%
 Max. Output Power Regulation: ±1.0%
 Max. Output Energy Regulation: ±1.0%
 Max. Output Efficiency Regulation: ±1.0%

READ INSTRUCTIONS BEFORE INSTALLING
 POWER CONNECTIONS CHARGE (BATTERY SENSING)
 INPUT: + BATTERY DIVERT (OPTIONAL) 12V MAX. 10V MAX. GND
 INDICATOR (OPTIONAL) 12V MAX. 10V MAX. GND

THE CONTROLLER WILL BE DAMAGED IF, WHILE CHARGING, THE POSITIVE SENSE WIRE, AND THE WIRE FROM THE BAT + TERMINAL ON THE CONTROLLER ARE CONNECTED TOGETHER, BUT REMOVED FROM THE BATTERY TERMINAL. TO PREVENT DAMAGE TO THE CONTROLLER, REMOVE ONE OF THE FUSES WHEN PERFORMING BATTERY MAINTENANCE

Do NOT charge a second battery bank with the Divert Output. It could be damaged by over or under charging

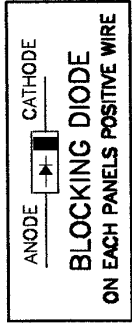

VOLTAGE SENSING WIRES MUST CONNECT DIRECTLY TO THE BATTERIES TERMINALS. ANY EXTENSIONS TO THIS WIRE MUST BE MADE WITH #14AWG WIRE OR LARGER.

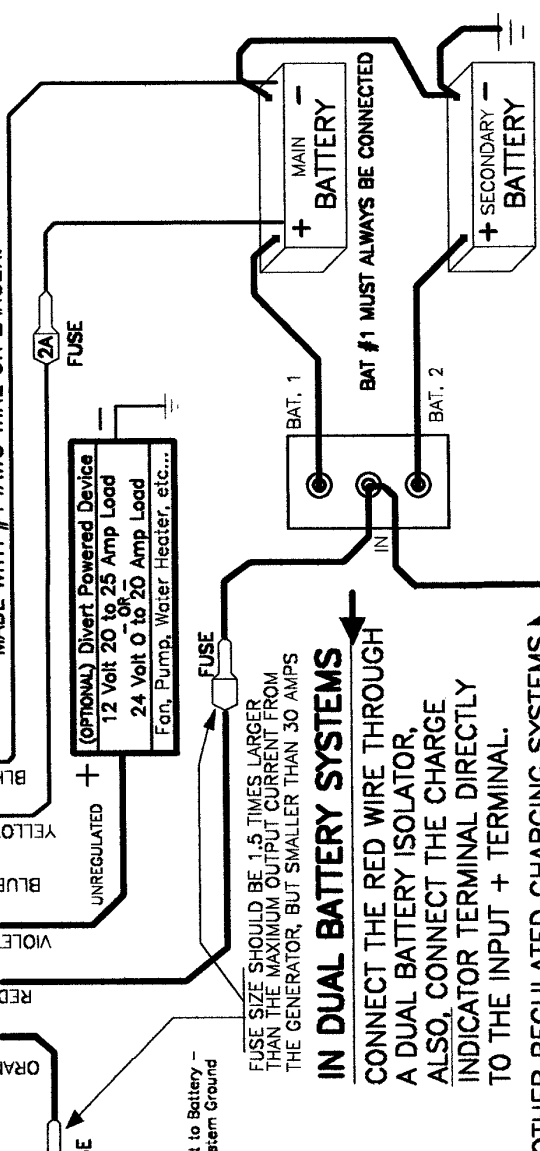

0.1A TO 25A
 FUSE
 Connect to Battery - and System Ground

IN DUAL BATTERY SYSTEMS
 CONNECT THE RED WIRE THROUGH A DUAL BATTERY ISOLATOR, ALSO, CONNECT THE CHARGE INDICATOR TERMINAL DIRECTLY TO THE INPUT + TERMINAL.
 FUSE SIZE SHOULD BE 1.5 TIMES LARGER THAN THE MAXIMUM OUTPUT CURRENT FROM THE GENERATOR, BUT SMALLER THAN 30 AMPS
 OTHER REGULATED CHARGING SYSTEMS (ALTERNATOR, GENERATOR, Etc...)

READ - VERY IMPORTANT !!!!
 The blocking diodes on the solar panels MUST HAVE A VOLTAGE A 200V OR HIGHER RATING to protect the panels from high voltage spikes that are normally produced by permanent magnet generators. THE PANELS WILL BE DAMAGED IF THESE

Drawing Shows 12V System. If Your Controller is For Other Voltage Systems, Multiply all Voltages as Listed Below

Sys. Voltage	Multiplier
24V	(x2)
36V	(x3)
48V	(x4)

CHARGING TWO BANKS USING A SELECTOR SWITCH FOR INDEPENDENT CHARGING OF BANK 1 OR BANK 2

DWG_81PCB Scale: 70%

Drawing Shows 12V System
If Your Controller is For Other
Voltage Systems, Multiply
all Voltages as Listed Below

Sys. Voltage	Multiplier
24V	(x2)
36V	(x3)
48V	(x4)

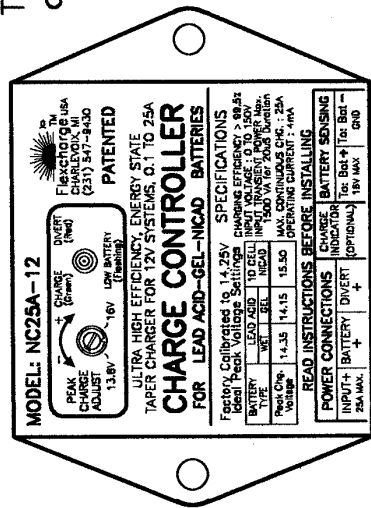

This is installation is preferred over using a standard 1-2-Both-Off battery switch VOLTAGE SENSING WIRES MUST CONNECT DIRECTLY TO THE BATTERIES TERMINALS. THIS WIRE MUST BE #14AWG OR LARGER.

Do NOT charge a second battery bank with the Divert Output. It could be damaged by over or under charging

DIVERT POWERED
ALTERNATE LOAD

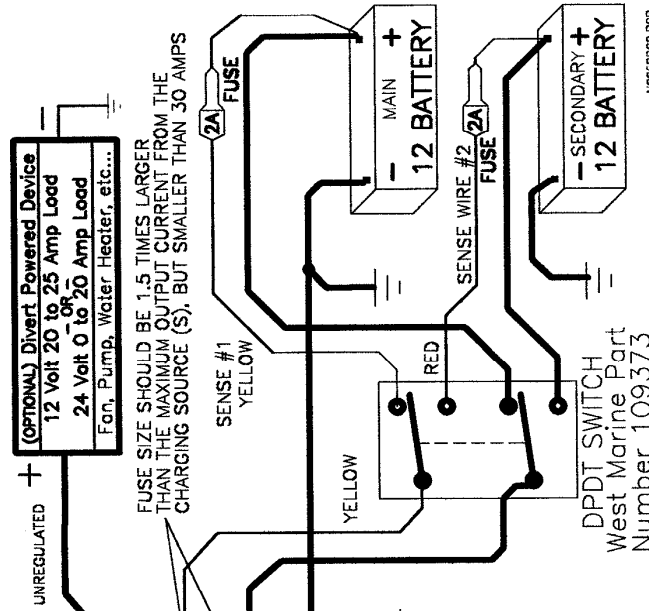

0.1A TO 25A
CHARGING SOURCE
SEE THE APPROPRIATE SKETCH

THIS SWITCH MUST HAVE A
HIGH ENOUGH AMPERAGE RATING
FOR ALL THE SOURCE CHARGING CURRENT

CAUTION: THE CONTROLLER WILL BE DAMAGED IF ...

- 1: THE CHARGING SOURCE IS CHARGING, AND
- 2: THE BATTERY YOU ARE CHARGING IS DISCONNECTED, AND
- 3: THE LARGE + CHARGING WIRE AND THE SENSE + WIRE ARE CONNECTED TOGETHER ALL AT THE SAME TIME

YOU WILL HEAR A BUZZING SOUND INDICATING WHEN THIS IS HAPPENING

NC25AFC2.PCB

CHARGING TWO BANKS USING A STANDARD BATTERY SWITCH

DWC_9.PCB Serie: 7/2x

Drawing Shows 12V System
If Your Controller is For Other
Voltage Systems, Multiply
all Voltages as Listed Below

Sys. Voltage	Multiplier
24V	(x2)
36V	(x3)
48V	(x4)

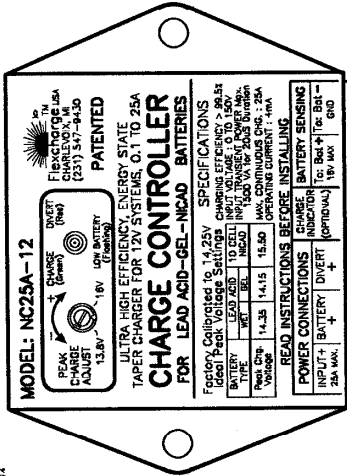

DUE TO THE POSSIBILITY OF OPERATOR ERROR
WE STRONGLY RECOMMEND USING A DUAL BATTERY
ISOLATOR, OR THE 2 POSITION SWITCH SHOWN
ON THE PREVIOUS PAGE OVER THIS METHOD.

VOLTAGE SENSING WIRES MUST CONNECT
DIRECTLY TO THE BATTERIES TERMINALS.
THIS WIRE MUST BE #14AWG OR LARGER.

Do NOT charge a second battery bank
with the Divert Output. It could be
damaged by over or under charging

See other drawings for how to
connect a divert load

FUSE OR BREAKER SIZE SHOULD BE 1.5 TIMES
LARGER THAN THE MAXIMUM OUTPUT CURRENT FROM
CHARGING SOURCE(S), BUT SMALLER THAN 30 AMPS

0.1A TO 25A
CHARGING SOURCE
SEE THE APPROPRIATE SKETCH

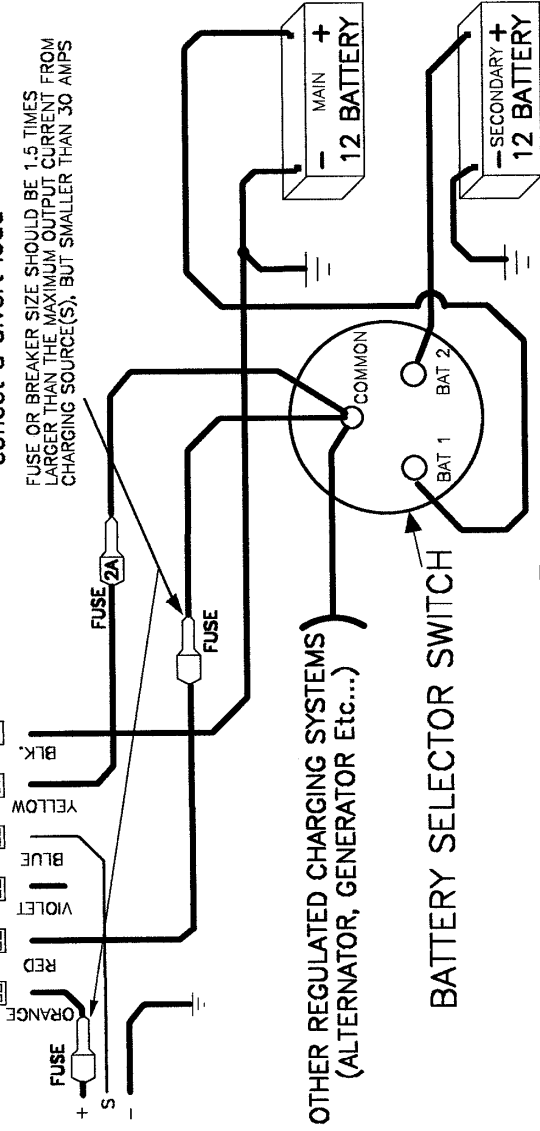

OTHER REGULATED CHARGING SYSTEMS
(ALTERNATOR, GENERATOR Etc...)

BATTERY SELECTOR SWITCH

CAUTION: THE CONTROLLER WILL BE DAMAGED IF
THE BATTERY SWITCH IS SWITCHED TO "OFF" OR A BATTERY
IS REMOVED. IF YOU WISH TO TURN THE BATTERY SWITCH "OFF"
YOU MUST REMOVE THE FUSE (OR SHUT OFF THE BREAKER)
INSTALLED IN THE RED WIRE. USING THE "BOTH" POSITION IS OKAY
YOU WILL HEAR A BUZZING SOUND INDICATING WHEN THIS IS HAPPENING

CHARGING FROM OUTBOARD MOTORS

12V Systems Only

THE CHARGE INDICATOR WILL NOT FUNCTION WHEN CHARGING FROM OUTBOARD MOTORS. WE SUGGEST USING A VOLTMETER TO MONITOR BATTERY VOLTAGE MAKING IT EASY TO DETERMIN WHEN THE BATTERY IS BEING CHARGED AND TO WHAT LEVEL IT IS CHARGED.

Note: IF YOUR OUTBOARD IS A PULL START, OR POWER TO THE STARTER IS NOT CARRIED ON THE CHARGING WIRES, THEN YOU DO NOT NEED TO USE THE AUTOMOTIVE STARTING SOLINOID.

OTHER CHARGING SOURCES, Positive Wire
Solar Panels, Unregulated battery chargers, etc...
Connect the negative wire from these sources to Bat -.
SEE CAUTION NOTE BELOW

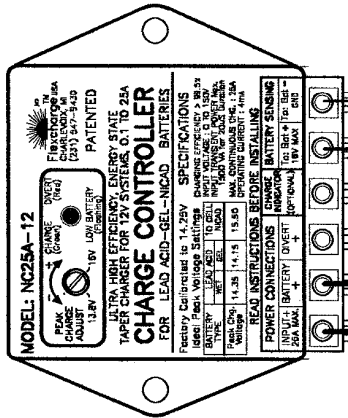

For dual battery bank charging disconnect from Bat+ and connect NC25A's BATTERY+ wire to a Dual Battery Isolator as shown. Connect outputs to the Bat+ of each battery.

OPTIONAL Dual battery Isolator

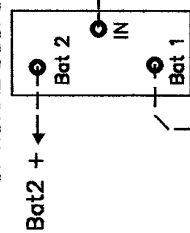

Fuse must be Rated at 30A or smaller. If Fuse Blows repeatedly install a "Slow Blow" Type

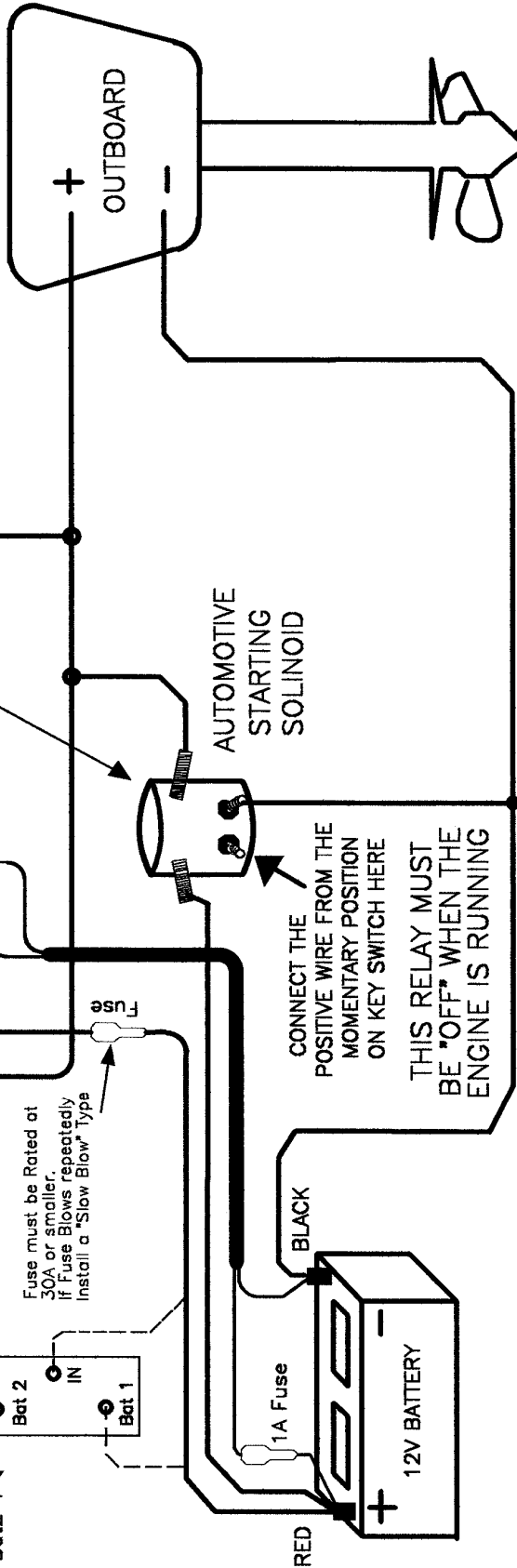

CAUTION: IF YOU PLAN TO USE SOLAR PANELS ON THE "OTHER CHARGING SOURCES" INPUT, THE PANELS MUST BE EQUIPPED WITH BLOCKING DIODES IN THE POSITIVE WIRE FROM EACH SOLAR PANEL, AND HAVE A RATING GREATER THAN 200V TO PROTECT THEM FROM THE HIGH VOLTAGE OUTPUTS THAT NORMAL OCCUR IN OUTBOARD MOTOR CHARGERS

EXPANDING THE NC25 INTO A HIGH AMPERAGE CHARGE CONTROLLER

60A, 75A, 100A OR MULTIPLE CONTACTORS MAY BE USED

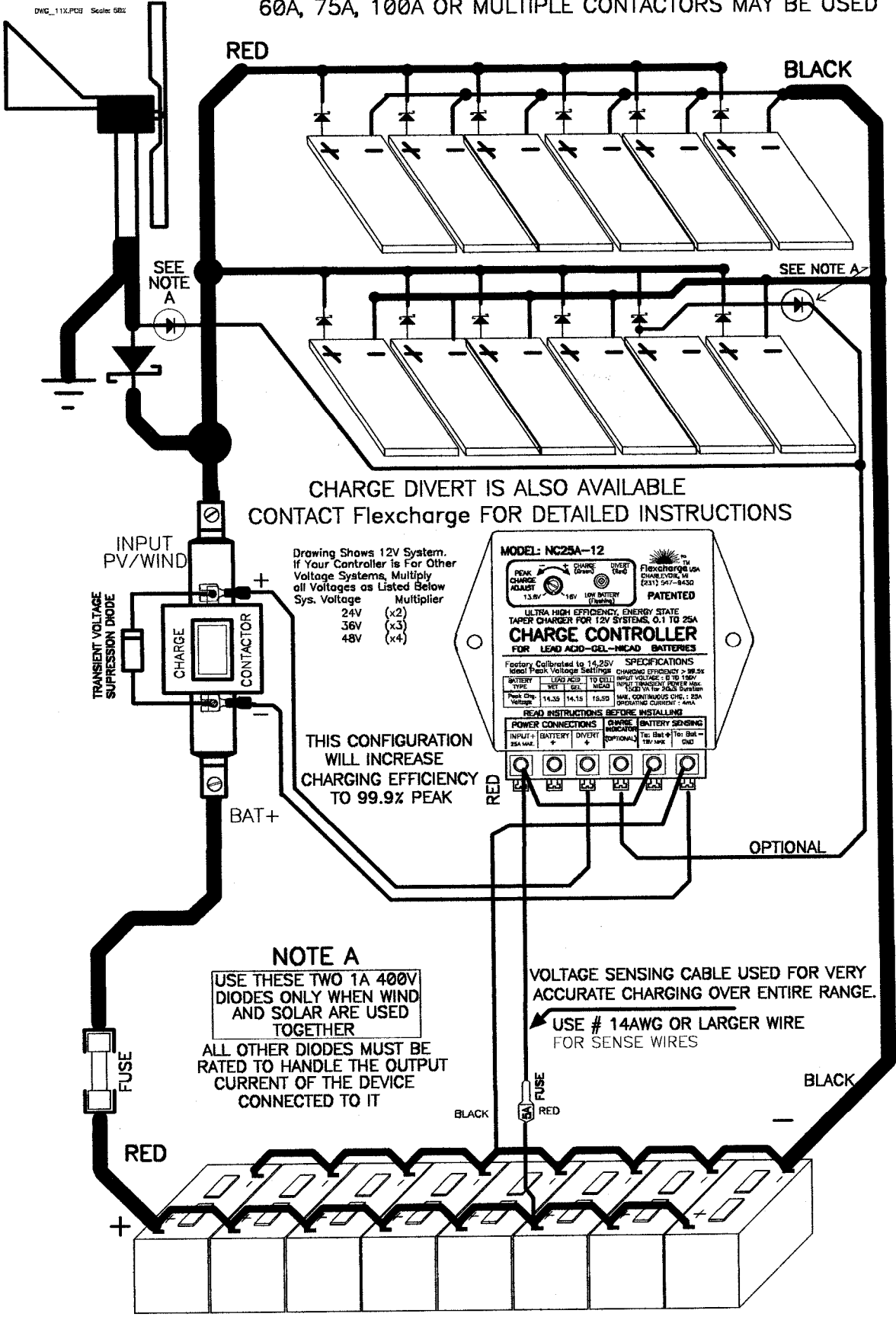

CHARGE CONTROLLER TROUBLESHOOTING GUIDE

IF YOU ARE USING CRIMP CONNECTORS, THEY MUST BE SOLDERED. CRIMP ONLY CONNECTIONS WILL ONLY MAKE GOOD CONNECTION FOR A SHORT PERIOD OF TIME, EVEN LESS IN A MARINE OR OUTDOOR ENVIRONMENT.

PROBLEM	SOLUTIONS
Charge Indicator does not light.	<p>Using the Charge Indicator is optional</p> <p>Verify that the Charge Indicator terminal is wired to the NON-BANDED side of a blocking diode on ONLY ONE OF THE SOLAR PANELS, or on the wind generator. (SEE THE INSTALLATION DRAWINGS). When charging through a diode type battery isolator the charge indicator terminal may be connected directly to the Input + terminal on the controller.</p> <p>Check the connection on the battery sense wires. The charge indicator will not light if the controller's BAT-wire is not connected.</p> <p>Disconnect the wire from the Charge Indicator terminal, and temporarily touch/connect it to +12V. You can use the Battery's Positive terminal (The Sense wires must be connected). It should light. If it does not see warranty return instructions.</p>
Charge Indicator is ON all the time.	<p>Verify that the Charge Indicator terminal is wired to the NON-BANDED side of a blocking diode on ONE OF THE SOLAR PANELS, or on the wind generator. (SEE THE INSTALLATION INSTRUCTIONS). The diodes found on the back of many models of Siemens Solar Panels are bypass diodes not blocking diodes. You may need to add blocking diodes to Siemens panels.</p> <p>If you are using the NC25 with a Battery Combiner the Charge Indicator wire must be connected to the charging source side of the blocking diode as shown in the installation drawings, also ; connect the battery sense wires to the Primary battery bank.</p>
The Divert Indicator does not illuminate.	<p>The controller must first reach the peak charge voltage before Divert will engage. This Indicator will only illuminate while the battery voltage is between the peak charge voltage and reconnect voltage (factory set at 14.25V / 13.6V, but is user adjustable).</p> <p>Check ALL the wire connections.</p> <p>Check the Battery Sense Ground Wire for a good connection. These wires are the only way the controller can determine battery voltage and control charging. A poor connection here could cause SERIOUS DAMAGE to your battery bank, and other electronics connected to it.</p> <p>Return the unit for warranty repair or replacement if it is less than 5 Years old and you have proof of purchase (See warranty restrictions).</p>
The controller does not switch to FLOAT/ DIVERT when the battery voltage is equal to, or above the Peak Charge Point.	<p>Ensure the Battery Sense Wires re making good connection. These wires are the only way the controller can determine battery voltage and control charging. A poor connection here could cause SERIOUS DAMAGE to your battery bank, and other electronics connected to it.</p> <p>Make Sure ALL wire to wire and crimp connections are soldered.</p> <p>Check the position of the Peak Charge Adjustment. Unless you have custom set this adjustment, it should be set to the dot on the case.</p>
The battery is being overcharged.	<p>Check the position of the Peak Charge Adjustment. It should be set at the small calibration dot on the case, unless you have custom set your peak charge voltage. DO NOT MOVE THE ADJUSTMENT unless you have calibrated test equipment and a fully charged battery bank to re-calibrate the controller. MIS-ADJUSTMENT COULD CAUSE SERIOUS DAMAGE TO YOUR EXPENSIVE BATTERY BANK. If it is not at the dot and you did not custom set your peak charge voltage, see the installation instructions for the calibration procedure, or call your dealer.</p> <p>Check the Battery Sense Wires for very good connections. These wires are the only way the controller can determine battery voltage and control charging.</p> <p>Make Sure ALL wire to wire and crimp connections are soldered .</p>
Controller makes a Buzzing sound.	<p>This will happen when the charging source is charging while the wire from the Controller's Battery + Terminal and the Sensing+ terminal wire are connected together, but removed from the Battery terminal. <i>If left in this state for even a few minuets the controller will be damaged.</i></p> <p>Disconnect the charging source, or separate the Controller's battery + terminal and the Sense + wires until the installation is completed. Removing one of the fuses will also stop this from occurring.</p>

Flexcharge™ USA NC25A

Charge Controller Operating Efficiency Graphs

NC25A Charging Efficiency & Power Consumption

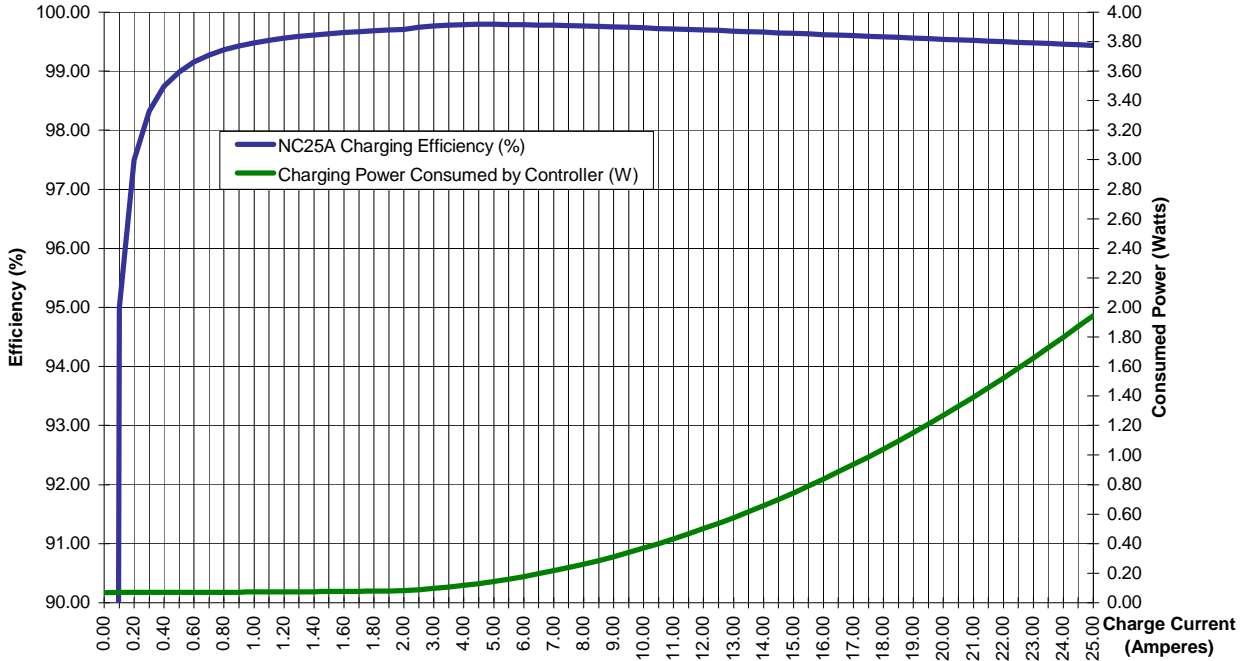

Efficiency Comparison: Flexcharge NC25A -to- Typical Alternative Energy Charge Controller

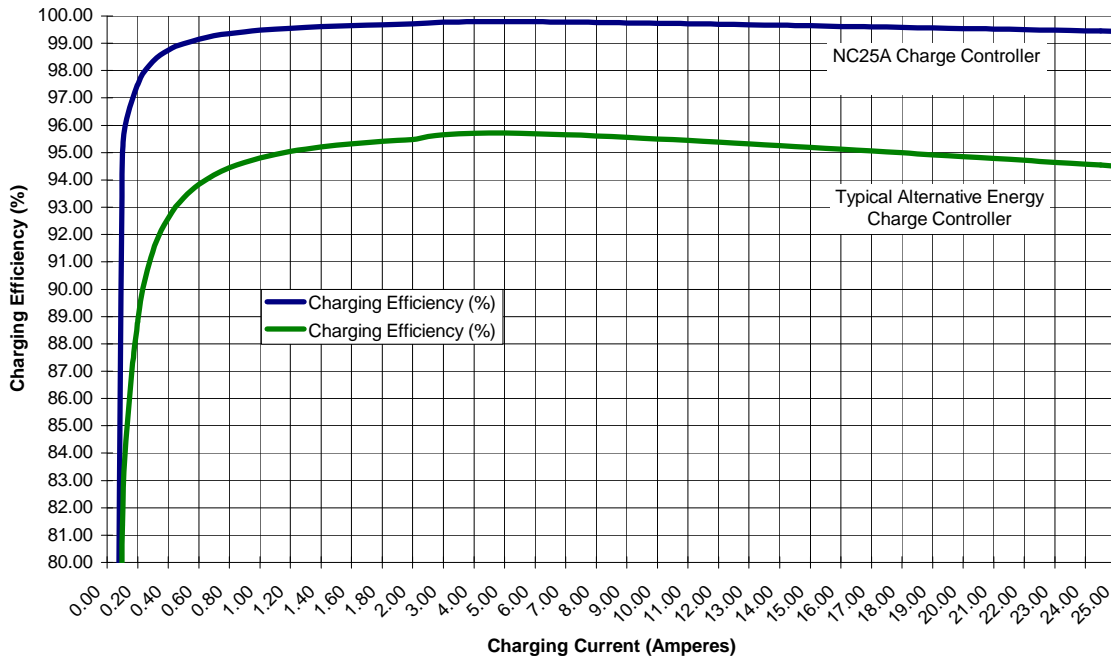

Special Note

IT IS NOT NECESSARY TO USE THE CHARGE INDICATOR ON THE NC25A. THE CONTROLLER'S OPERATION WILL NOT BE AFFECTED IN ANY WAY.

THE CHARGE INDICATOR IS CONNECTED SEPARATELY TO ACHIEVE THE ULTRA HIGH CHARGING EFFICIENCY FOUND IN THE NC25A CHARGE CONTROLLER. THE CONTROLLER USES 5mA WHEN USING THE INDICATOR, 2mA WITHOUT.

DESIGNING YOUR SYSTEM

There is nothing magic about solar electric power. If the system is designed and sized right, it will do the job with little attention from the owner. A poor design will be a constant source of aggravation. It is generally best to have assistance from someone familiar with designing an alternative energy system. The following is a brief introduction to the information that needs to be considered to match a system to a job.

Year around or seasonal use? One sun hour is equal to one hour of sunlight, at high noon, on a clear day, in the summer. A sun low in the sky is not going to equal one sun hour because it is shining through more atmosphere. Because the number of sun hours varies from day to day and season to season in many parts of the world, it is important to consider the time of year the system is will be used, and design it for the worst conditions. Clear day full sun hours in the USA will vary from 1 hour to 6 hours depending on location and season. It is also necessary to compensate for cloudy days. Our practice is to double the number of solar panels that the shortest "sun hour days" dictate.

The Load. Keeping the load as small a possible will keep the number of solar panels down to a minimum, and therefore the cost down. Using high efficiency lighting in a system will reduce your system lighting power needs by 5 times. 1/5 of what would be required for the equivalent incandescent lighting. The power requirements will need to be calculated in watt hours or amp hours for power used on a daily basis, then multiply this number by 2. Next divide by the number of sun hours you will get on the shortest days in your area. This will give you the size of your solar panel array. Using this conservative method you should never be without power.

Batteries. The battery is the storage tank for your electricity. Too large a battery bank will always be in a state of discharge, and have a reduced life, while too small a battery bank will not have enough reserve to carry the system through a group of cloudy days. Three to four times your daily load is a good balance. The best value is the wet cell lead acid deep cycle type. For portable systems the "gel cell" and AGM lead acid types are good. Wet "Ni-Cad" batteries are also good, but expensive and need special considerations in the system design. When considering your overall system size you need to allow a 30% overage for losses in the chemical processes taking place in the batteries.

Charge Controllers. A system that has the capacity to charge up a discharged system, also has the capacity to overcharge the batteries. A charge controller will prevent overcharging and give your batteries a much longer life with less maintenance. It needs to have an amp rating at or above the maximum amp rating of your charging system. It is often sized larger to give additional capacity for adding more panels in the future.

Solar panels. Rigged framed models are ideal for the remote cabin, agricultural, and communications applications
There are many other considerations in designing a solar powered system, including; wire sizes, location etc...

Flexcharge™ USA PRODUCTS WARRANTY

Flexcharge USA products PV model controllers are warranted for a period of two years. Five years on NC series charge controllers, and one year on lighting products, from the date of purchase, subject to the conditions set forth below. This warranty to the original purchaser, warrants the products to be free from material and workmanship defects. During the warranty period, the product will be repaired or replaced, at the option of Flexcharge USA, free of charge. Shipping not included. Products from other manufacturers that are incorporated into Flexcharge USA products such as solar panels and batteries, are covered by warranties from those manufactures.

CONDITIONS

- 1. Proper delivery:** The product must be packed to prevent damage and shipped to SES Flexcharge USA, 1217 State St., Charlevoix, MI 49720 USA, freight prepaid and including:
 - a. Proof of purchase. (invoice showing product and date)
 - b. Description of problem.
- 2. Abuse, misuse, negligence, unauthorized repairs:** The warranty is void if any defects are caused by abuse, misuse, negligence, or unauthorized repairs. Damage caused by lightning is considered an act of God and is not warranted.
- 3.** All liability for incidental or consequential damages is specifically excluded. Some states do not allow the exclusion or limitation of incidental or consequential damages so the above limitation or exclusion may not apply.